

CULINA

LIGHTING CATALOGUE





“ Modern & professional lighting range for commercial & domestic applications

ABOUT US

Culina has been a leading brand of Kitchen Lighting for almost a decade, specialising in innovative LED solutions for Kitchen and Furniture applications.

This latest catalogue coincides with the launch of 3 new products ranges that we're very excited about:

Firstly our best selling 240V under cabinet lights are now available with CCT, colour changing technology. Now not only can you install these items without the use of an LED driver, you can also choose between 3000k (warm white), 4000k (cool white) and 6000k (daylight white), enabling the user to select the light best suited to their kitchen.

Secondly our extensive new Culina Konect range gives the planner and installer the simplicity of choosing this plug and play system. There's no hard wiring required and with the range including under cabinet lights, link lights, plinth lights and LED tape,

the installer can interlink a wide variety of lighting to best suit their specific kitchen. In addition to the varied light sources there are also a number of controls available in the konect system, which include motion sensors, touch sensors and door sensors.

To compliment the above we have introduced the new wireless Kinetic Switch System, which allows your lighting to be controlled by using a wireless switch, smart phone or tablet app, or through Smart Voice Controlled devices .

With these new additions to the range the Culina brand has never been better equipped to offer everything required to best illuminate your kitchen or living space.

CONTENTS

Under Cabinet Spot Lighting

- 07 Fonte
- 07 Faro
- 07 Ayla
- 07 Lago
- 09 Pozza
- 09 Laghetto
- 09 Ellen
- 09 Argi

Under Cabinet Link Lighting

- 10-11 Rechargeable
- 12 Legare
- 13 Bude

Konect Plug & Play System

- 14-15 System Overview
- 16-17 Under Cabinet Spot
- 18 Under Cabinet Strip
- 19 LED Strip
- 20-21 Plinth
- 23-24 Drivers
- 25 Accessories
- 26-27 Sensors

Plinth Lighting

- 22 Ohio

Charging

- 28 Pop-up Socket
- 29 Wireless Qi

Kinetic Switching

- 30-31 System Overview
- 32 Switches
- 32 Receivers

Other

- 33-35 Downlights
- 36-37 Cable Sets
- 38-39 Shades
- 40-41 LED Lamps



REFERENCES

ICON GUIDE

All of our products have their own unique features. The below icons will help as a guide.



Suitable for kitchens



IP rating of fitting



Fire rated



Suitable for bedrooms



SMD LED



COB LED



Suitable for bathrooms



Guarantee



LED changeable colour temperature (CCT)



Warm white colour temperature



Cool white colour temperature



Daylight white colour temperature



Touch sensor switch



PIR sensor switch



IR sensor switch



Konect system



No driver required



Rechargeable



Cable length



Bluetooth speaker



WiFi connectivity



Dimmable



Kinetic switching system



Recessed or surface mount



**WARM WHITE
3000K**



**COOL WHITE
4000K**



**DAYLIGHT WHITE
6000K**

FONTE UNDER CABINET LIGHT



- No driver required
- Great value cabinet light
- 1.5W LED
- Polycarbonate diffuser
- 1m length cable
- SMD LED

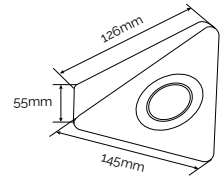

Code	Colour (k)	Power (w)	Lumens	Beam Angle	Size
CUL-25319-WW	3000K	1.5W	130	120°	126 x 145 x 32mm
CUL-21626-CW	4000K	1.5W	140	120°	126 x 145 x 32mm
CUL-25219-DW	6000K	1.5W	150	120°	126 x 145 x 32mm

FARO UNDER CABINET LIGHT



- No driver required
- Colour changing technology
- 1.5W LED
- Polycarbonate diffuser
- 1m length cable
- SMD LED

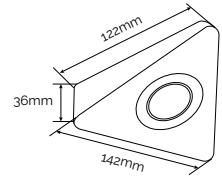

Code	Colour (k)	Power (w)	Lumens	Beam Angle	Size
CUL-35861	CCT	1.5W	120	120°	122 x 142 x 36mm

AYLA UNDER CABINET LIGHT



- No driver required
- Colour changing technology
- 3W LED
- Polycarbonate opal diffuser
- 1m length cable
- SMD LED

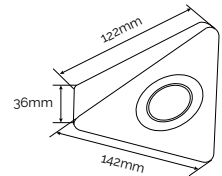

Code	Colour (k)	Power (w)	Lumens	Beam Angle	Size
CUL-35865	CCT	3W	180	120°	122 x 142 x 36mm

LAGO UNDER CABINET LIGHT



- No driver required
- Great value cabinet light
- 1.5W LED
- Polycarbonate diffuser
- 1m length cable
- SMD LED

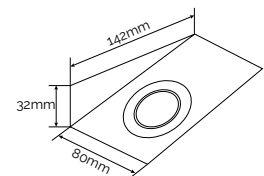

Code	Colour (k)	Power (w)	Lumens	Beam Angle	Size
CUL-25320-WW	3000K	1.5W	130	120°	142 x 80 x 32mm
CUL-21627-CW	4000K	1.5W	140	120°	142 x 80 x 32mm
CUL-25220-DW	6000K	1.5W	150	120°	142 x 80 x 32mm



WARM WHITE
3000K



COOL WHITE
4000K



DAYLIGHT WHITE
6000K

POZZA RECESSED UNDER CABINET LIGHT



- No driver required
- Great value cabinet light
- Up to 150 lumens
- Polycarbonate diffuser
- 1m length cable
- SMD LED

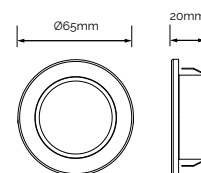

Code	Colour (k)	Power (w)	Lumens	Beam Angle	Size	Cutout
CUL-25317-WW	3000K	1.5W	130	120°	Ø65 x 20mm	
CUL-21624-CW	4000K	1.5W	140	120°	Ø65 x 20mm	
CUL-25217-DW	6000K	1.5W	150	120°	Ø65 x 20mm	

LAGHETTO UNDER CABINET LIGHT



- No driver required
- Great value cabinet light
- Can be surface mounted or recessed
- Up to 150 lumens
- Polycarbonate diffuser
- 1m length cable
- SMD LED

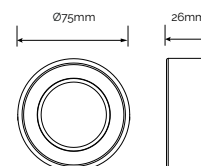

Code	Colour (k)	Power (w)	Lumens	Beam Angle	Size	Cutout
CUL-25318-WW	3000K	1.5W	130	120°	Ø75 x 20mm	
CUL-21625-CW	4000K	1.5W	140	120°	Ø75 x 20mm	
CUL-25218-DW	6000K	1.5W	150	120°	Ø75 x 20mm	

ELLEN UNDER CABINET LIGHT



- No driver required
- Colour changing technology
- 120 Lumens
- Polycarbonate diffuser
- 1m length cable
- SMD LED
- Can be recessed or surface mounted with removeable spacer

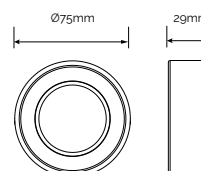

Code	Colour (k)	Power (w)	Lumens	Beam Angle	Size	Cutout
CUL-35860	CCT	1.5W	120	120°	Ø75 x 29mm	

ARGI UNDER CABINET LIGHT



- No driver required
- Colour changing technology
- 180 lumen output
- Polycarbonate diffuser
- 1m length cable
- SMD LED
- Can be recessed or surface mounted with removeable spacer

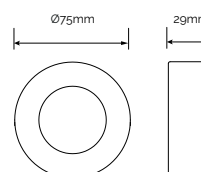

Code	Colour (k)	Power (w)	Lumens	Beam Angle	Size	Cutout
CUL-35864	CCT	3W	180	120°	Ø75 x 29mm	



**USE INSIDE
CUPBOARDS**



**USE INSIDE
WARDROBES**

RECHARGEABLE UNDER CABINET LIGHTS

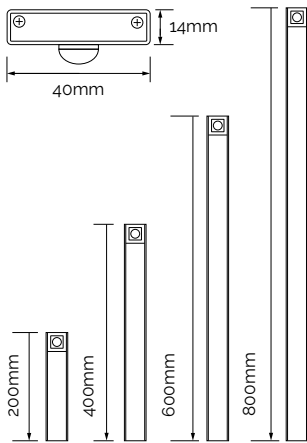

The slimline rechargeable cabinet light can be used for multiple applications such as your wardrobe, kitchen cupboard, bathroom counter, under cabinet, under the stairs or garage. No wiring is required and installation is easy with the adhesive magnetic strip provided. The light can be set to AUTO ON, ALWAYS ON or OFF. When set to AUTO ON, the light will automatically turn on when the PIR is activated by human motion from up to a 3 metre distance.

RECHARGEABLE UNDER CABINET LIGHT

Code	Colour (k)	Power (w)	Lumens	Battery	Run Time (h)	Size
CUL-37386	4000K	1W	90	750mAh Li-ion	4 Hours	200 x 40 x 9mm
CUL-37387	4000K	2W	160	1100mAh Li-ion	5 Hours	400 x 40 x 9mm
CUL-37388	4000K	3W	230	1500mAh Li-ion	5 Hours	564 x 40 x 9mm
CUL-37389	4000K	4W	350	2200mAh Li-ion	5 Hours	864 x 40 x 9mm

Charge Time (h) 4 hours to full battery



- Step 1: Choose colour temp
- Step 2: Choose length
- Step 3: Find item code

LEGARE LED UNDER CABINET LIGHTS

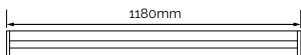
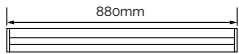
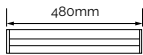
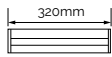
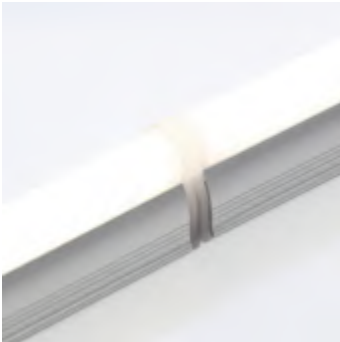

The Legare range is adaptable and best suited for under cabinet lighting. This premium model has an aluminium frame and a polycarbonate diffuser and comes in a variety of sizes, link leads and different colour temperature between 3000K (warm white) and 4000K (cool white). Legare range provides continuous light flow when link lights are butted up together with an opal diffuser that distributes the light evenly.

LEGARE UNDER CABINET LINK LIGHT

STEP 1 Choose your colour temperature	320mm, 4W • 400 lumens	480mm, 7W • 700 lumens	880mm, 12W • 1000 lumens	1180mm, 14W • 1200 lumens
3000K Warm White (WW)	CUL-25321	CUL-25322	CUL-25323	CUL-25324
4000K Cool White (CW)	CUL-21661	CUL-21662	CUL-21663	CUL-21664
CCT 3000K 4000K (CCT)	CUL-34223-CCT	CUL-34223-CCT	CUL-34223-CCT	CUL-34223-CCT



BUDE

UNDER CABINET LIGHTS

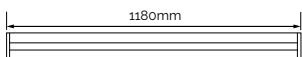
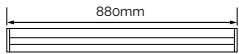
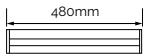
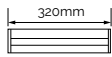

Bude under cabinet link light is finished in white and features white PC body with opal diffuser and ON/OFF rocker switch. The lights can provide a continuous light flow when link lights are butted up together.

BUDE UNDER CABINET LINK LIGHT

STEP 1 Choose your colour temperature		320mm, 4W • 400 lumens	480mm, 7W • 700 lumens	880mm, 12W • 1000 lumens	1180mm, 14W • 1200 lumens
3000K	Warm White (WW)	ELA-28418	ELA-28419	ELA-28420	ELA-28421
4000K	Cool White (CW)	ELA-28414	ELA-28415	ELA-28416	ELA-28417





KONECT PLUG & PLAY SYSTEM

The Konect plug and play system features revolutionary wiresafe technology. Designed to protect all ports from overloading, short circuits and electrical surges, ensuring lighting systems stay as safe as possible. In turn conforming to BS7671 Regulations.

✓ **Easy to install**
no hard-wiring required

✓ **Customisable**
control & dim your lighting
exactly the way you want

✓ **Versatile**
Run multiple lights off one
multi-port driver

KONECT SYSTEM OVERVIEW

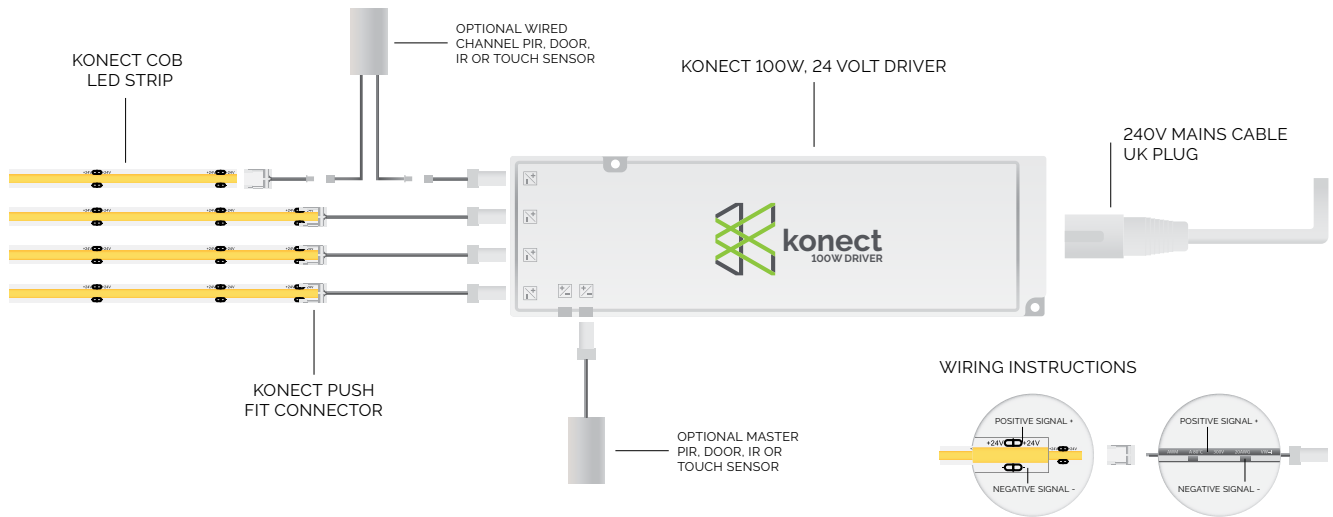

The new Konect connectors on each component are designed to only fit into the respective ports further enhancing safety.

Offering this balance of maximum safety and simplicity means less need for electrical qualifications on installation, saving you time and money on your next lighting project.

We have a range of drivers with a range of up to 7 connection ports and can power up to 100 watts worth of LED Lights in one 24 Volt lighting system. Full customisable with UK plugs available in 3 lengths, extension cables and a range of lighting you will be sure to find something suitable for your needs.

KONECT UNDER CABINET LIGHTS

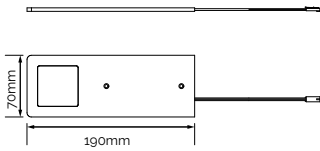

The slimline under cabinet spot is made entirely from aluminium, with a thickness of only 4mm. The high light intensity is guaranteed by a cluster of 24 highly performing LEDs for 5W of total power which can be connected our Konect plug and play system. Designed for fast surface installation through a panel fixing mechanism that requires only two screws allowing you to easily hide the power cable directly on the back of the cabinet.

SLIMLINE UNDER CABINET SPOTLIGHT

Code	Colour (k)	Power (w)	Lumens	Beam Angle	Size
CUL-37797	3000K	5W	350	120°	190 x 70 x 4mm
CUL-3779	4000K	5W	350	120°	190 x 70 x 4mm

DRIVER REQUIRED



KONECT UNDER CABINET LIGHTS



This under cabinet light is designed for surface mounting or recessed mounting with a Ø60mm hole and installation depth of only 8mm. It is installed in wooden panels with both through and blind holes. The fixing system, with two lateral springs, is quick and does not require any tools

RECESSED/SURFACE ROUND UNDER CABINET LIGHT

Code	Colour (k)	Power (w)	Lumens	Beam Angle	Size
CUL-37795	3000K	1.8W	150	120°	Ø65 x 10mm
CUL-37796	4000K	1.8W	150	120°	Ø65 x 10mm

DRIVER REQUIRED



KONECT SENSOR LIGHTS

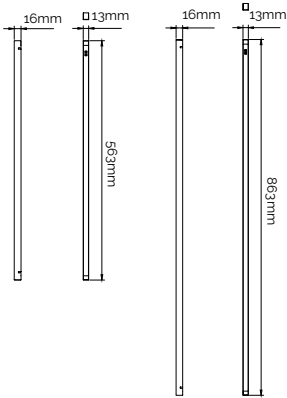

The mini drawer light with infra-red sensor is ideal for kitchen drawers and wardrobes. The light is activated when the drawer is opened and switches itself off when the drawer is closed. Available in an aluminium finish.

IR MINI CABINET/DRAWER LIGHT

Code	Colour (k)	Power (w)	Lumens	Beam Angle	Size	Length
CUL-37787	3000k	3.5w	220	120°	15.5 x 13mm	563mm
CUL-37788	4000k	3.5w	220	120°	15.5 x 13mm	563mm
CUL-37789	3000k	5.2w	460	120°	15.5 x 13mm	863mm
CUL-37790	4000k	5.2w	460	120°	15.5 x 13mm	863mm

DRIVER REQUIRED



KONECT FLEXIBLE STRIP LIGHTING

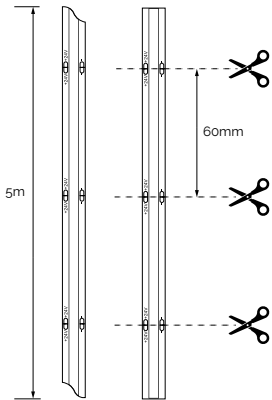

KONECT flexible LED COB strip comes in a 5m rolls that can be divided every 5cm. A CONNECTOR can be used to join multiple pieces of strip lighting minimising wastage and also makes it possible to create a continuous flexible LED COB strip up to a maximum length of 6m. The compact dimensions ensure even light projection without shadow areas. The POWER CONNECTOR connects the LED strip to the driver without the use of any equipment and without soldering cables. The STRIP TO STRIP WIRE connector is perfect for wiring round corners. The STRIP TO STRIP connector joins two modules and guarantees electrical continuity. A professional cutting service is also available. Please get in touch with our sales department for more information,

8MM LED COB STRIP

Code	Colour (k)	Power (w/m)	Lumens (p/m)	Beam Angle	CRI	Length
ELA-35750	3000k	12w	896	180°	>90	5m
ELA-37550	4000k	12w	934	180°	>90	5m

DRIVER REQUIRED

POWER CORD REQUIRED



KONECT PLINTH LIGHTS

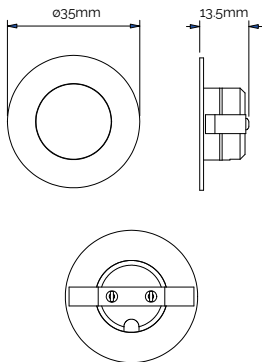

The Round LED plinth light comes in a matt silver finish and is part of our Konect Plug & Play range. Designed to fit flush with the plinth with its super slim profile. The fixing system is simple. Two lateral steel springs, is quick and easy and does not require any tools. Each light has a long 2m cable which can be extended if needed with our extension cable range on page 23.

ROUND PLINTH LIGHT

Code	Colour (k)	Power (w)	Lumens	Beam Angle	Size	Cutout
CUL-37791	3000K	1.2W	100	100°	Ø35 x 13.5mm	Ø32mm
CUL-37792	4000K	1.2W	100	100°	Ø35 x 13.5mm	Ø32mm

DRIVER REQUIRED



KONECT PLINTH LIGHTS



The Square LED plinth light comes in a matt silver finish and is part of our Konect Plug & Play range. Designed to fit flush with the plinth with its super slim profile. The fixing system is simple. Two lateral steel springs, is quick and easy and does not require any tools. Each light has a long 2m cable which can be extended if needed with our extension cable range on page 23.

SQUARE PLINTH LIGHT

Code	Colour (k)	Power (w)	Lumens	Beam Angle	Size	Cutout
CUL-37793	3000K	1.2W	100	100°	35 x 35 x 13.5mm	Ø32mm
CUL-37794	4000K	1.2W	100	100°	35 x 35 x 13.5mm	Ø32mm

DRIVER REQUIRED



240V PLINTH LIGHTS

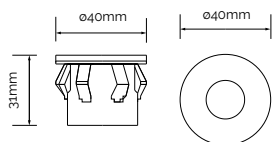

240V plinth lights require no driver and are not part of the Konect range

Our 240V plinth lights feature a brushed steel finish and come in 2 colour temperatures. They do not require a driver to install and have 20,000 hours LED lifespan. They're also rated IP65 and have a 2 meter cable.

240V PLINTH LIGHTS

Code	Colour (k)	Power (w)	Lumens	Beam Angle	Size	Cutout
CUL-26465-WW	3000k	0.5w	20	120°	Ø40mm	Ø35mm
CUL-26465-CW	4000k	0.5w	20	120°	Ø40mm	Ø35mm

NO DRIVER REQUIRED



KONECT 24V PLUG & PLAY MULTI-PORT DRIVERS

The driver is the heart of the Konect plug & play system, and is suitable for connecting to all of the world's power systems. It has an integrated switching function and connections for all of the most popular types of switch.

- Solderless circuit connection - no hard-wiring required
- No need for an electrician
- Plug & play LED strip lighting solution
- Compatible with Konect sensors and dimmers for solderless controllable strip lighting
- Driver contains a fuse to assist with BS7671 Regulation



18W/24V DRIVER / CONVERTER

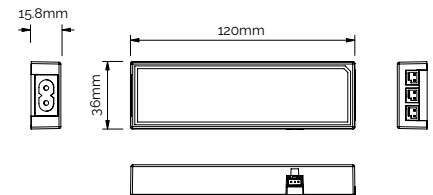

Code	Input	Output	Load	Size	Depth	Output Socket	Guarantee
CUL-27767	AC200-240V	24V	18W	120 x 36mm	15mm	3 ports	3 Years

24W/24V DRIVER / CONVERTER

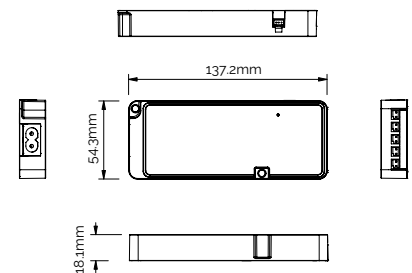

Code	Input	Output	Load	Size	Depth	Output Socket	Guarantee
CUL-27768	AC200-240V	24V	24W	138 x 55mm	18mm	5 ports	3 Years

36W/24V DRIVER / CONVERTER

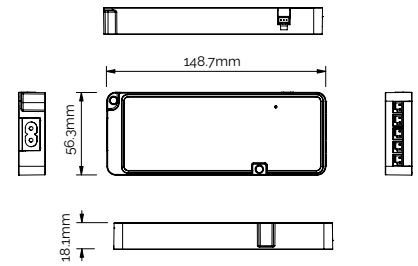

Code	Input	Output	Load	Size	Depth	Output Socket	Guarantee
CUL-37769	AC200-240V	24V	36W	148 x 55mm	18mm	5 ports	3 Years

60W/24V DRIVER / CONVERTER

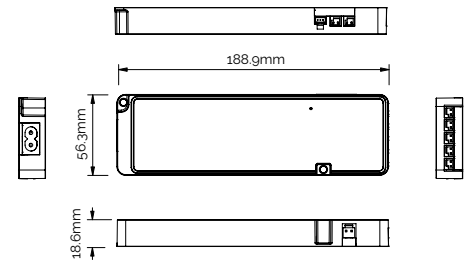

Code	Input	Output	Load	Size	Depth	Output Socket	Guarantee
CUL37770	AC200-240V	24V	60W	189 x 55mm	15mm	7 ports	3 Years

100W/24V DRIVER / CONVERTER

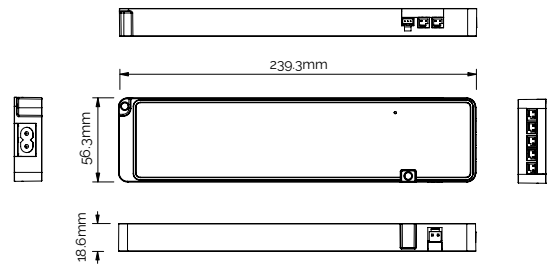

Code	Input	Output	Load	Size	Depth	Output Socket	Guarantee
CUL-37771	AC200-240V	24V	100W	239 x 56mm	18mm	7 ports	3 Years

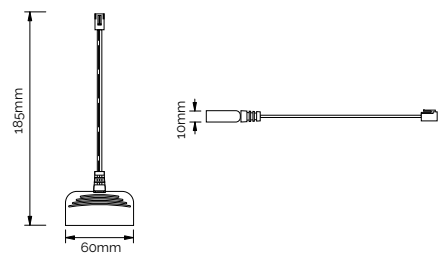

MICRO DISTRIBUTOR

Code	Connector	Size	Depth	Output Socket	Cable Length
CUL-37786	Micro24	60 x 45mm	10mm	6 slots	120mm

KONECT ACCESSORIES



POWER CONNECTOR

Code	Description
CUL-37801	8mm COB dupont to strip soldering free connector

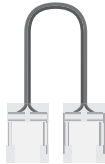

STRIP TO STRIP WIRE CONNECTOR

Code	Description
CUL-37802	8mm COB strip to wire to strip soldering free connector



STRIP TO STRIP CONNECTOR

Code	Description
CUL-37803	8mm COB strip to strip soldering free connector



UK PLUG TO 'FIGURE-8' (C7) TYPE MAINS LEAD

Code	Input	Cable Length	Colour
CUL-37783	AC200-240V	1000mm	White
CUL-37784	AC200-240V	1500mm	White
CUL-37785	AC200-240V	1800mm	White



EXTENSION CABLE

Code	Connector	Cable Length	Colour
CUL-37772	Micro 24 male/female connector	1200mm	White
CUL-37773	Micro 24 male/female connector	1800mm	White
CUL-37774	Micro 24 male/female connector	2400mm	White

KONECT PLUG & PLAY SENSORS



Master Door Sensor



Master Door Sensor

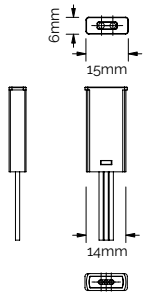

IR DOOR SENSOR

The infra red door sensor switch enables you to switch lights on and off within cabinets without touching any buttons, using the infra red sensor. The switch senses when the cupboard door is opened and automatically turns the light on, and when the cupboard door is shut the lights are instantly switched off, saving energy and money.

Code	Control Mode	Max Load	Size	Cable Length
CUL-37775	Master	-	38 x 32 x 5mm	1500mm
CUL-37776	Channel	60W	38 x 32 x 5mm	2 x 1500mm

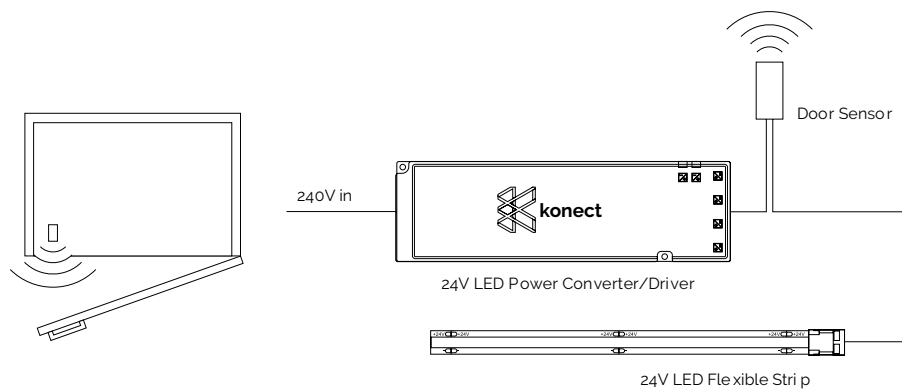



HAND MOTION SENSOR

Simply swipe your hand below the sensor within a 8cm distance enabling you to switch on and off any lighting without touching any buttons.

Code	Control Mode	Max Load	Size	Cable Length
CUL-37781	Master	-	38 x 32 x 5mm	1500mm
CUL-37782	Channel	60W	38 x 32 x 5mm	2 x 1500mm

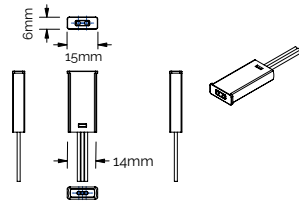

PIR SENSOR

PIR sensor turns on the lighting when movement is detected within a 3m distance. The sensor has a 35 second timing delay so once no further movement is detected the lighting will automatically power off. This can be recessed into the cupboard or mounted flush with the extra bracket provided.

Code	Control Mode	Max Load	Size	Cable Length
CUL-37777	Master	-	38 x 32 x 5mm	1500mm
CUL-37778	Channel	60W	38 x 32 x 5mm	2 x 1500mm

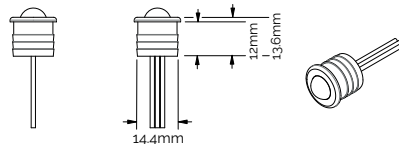

TOUCH SENSOR

The touch sensor features a blue backlit light has a slimline design and is great for a recessed application. Short touch for on/off function or long press for dimming.

Code	Control Mode	Max Load	Size	Cable Length
CUL-37779	Master	-	38 x 32 x 5mm	1500mm
CUL-37780	Channel	60W	38 x 32 x 5mm	2 x 1500mm

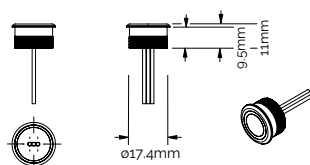

POP UP SOCKET

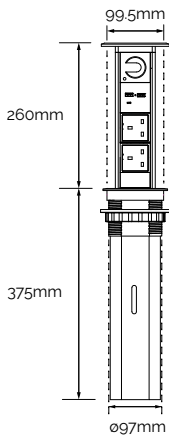

The contemporary pop up socket is a great slimline addition to your worktop. This motorised pop up edition is sleek and stylish boasting 2 sockets and 2 USB ports to charge USB devices. It also features a wireless bluetooth speaker.

POP UP SOCKET

Code	Sockets	USB Ports	Speaker	Size
CUL-37800	2	4.5w	1 x 2w	Ø99.5 x 260mm (when extended from surface)



WIRELESS QI CHARGER

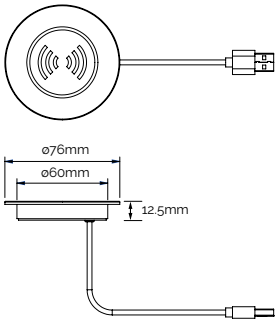

Integrated wireless charger compatible with Qi enabled devices. Simply place the Qi enabled product onto the charger to begin wireless power transmission.

WIRELESS QI CHARGER

Code	Input	Output
CUL-37799	5V-2A	10W/7.5W/5W

- 10W Fast Charge Mode: Using QC 2.0/3.0 Adapter: Galaxy S20 / S10 / S10+ / S10e / S9+ / S9 / Galaxy Note 10 / Note 9
- 7.5W Fast Charge Mode: Using QC 2.0/3.0 Adapter: iPhone11 Pro Max / iPhone XR / iPhone 8 SE / iPhone 8 Plus

KINETIC WIRELESS SWITCHING

The wireless switch uses micro-energy acquisition technology. Kinetic energy is generated to create and transmit a radio signal to the receiver which in turn, will switch lamps or other loads on or off.

There is no longer the constraint of wiring location and no need to install back boxes or cut holes into walls. The kinetic switch can be installed anywhere or placed to maximise convenience.

✓ Wireless

no hard-wiring required

✓ 100% Safe

waterproof design no risk of electric shock

✓ Versatile

control your lighting via wall plate switch, smartphone app or alexa/google voice control



KINETIC

SYSTEM OVERVIEW



PUSH SWITCH TO CREATE KINETIC ENERGY



INTERNAL MODULE COLLECTS KINETIC ENERGY



KINETIC ENERGY IS CONVERTED INTO ELECTRICITY



COMMUNICATION MODULE TRANSMITS SIGNAL



RECEIVER CONTROLS LIGHT AND SWITCHES ON/OFF

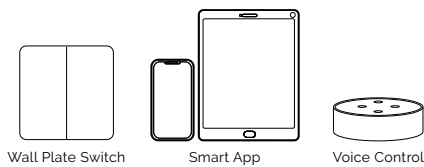

Wall Plate Switch

Smart App

Voice Control

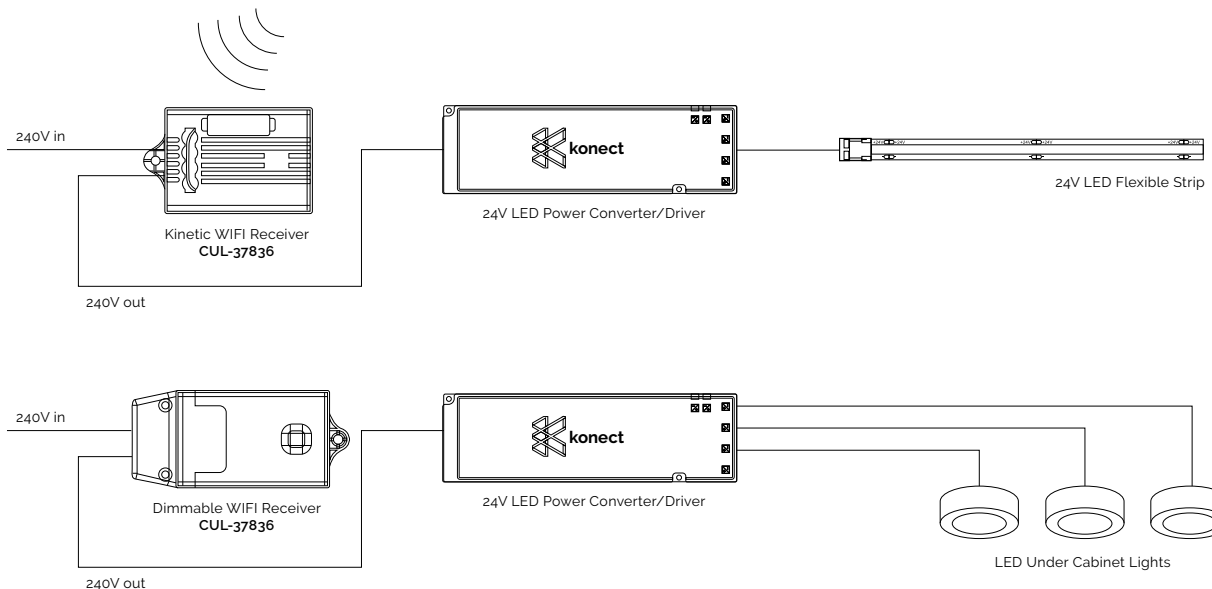

- Lighting can be controlled manually by using the switch, smart phone or tablet using the Smart Life App or connecting it to a voice controlled device such as Amazon Alexa or Google Home.
- The kinetic switches require no wiring or batteries which eliminates the need for installing back boxes, creating channels in walls and adjusting decor, thus speeding up the installation process and reducing labour time & costs.
- The switch can be installed anywhere in the home, including the bathroom due to its IP67 rating. The switches can be screwed to the surface, or stuck on with the adhesive pads supplied. They can also be retro-fit onto existing back boxes as they are the same size as standard switches.



1 GANG SWITCH

IP67 on/off 1 gang switch. Dimmable by long pressing when used with a dimmable receiver.

Code	Description	Finish
ELA-37521	8mm X-Shape Connector 12-24V	White

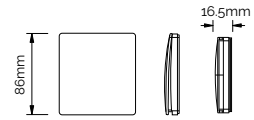

2 GANG SWITCH

IP67 on/off 1 gang switch. Dimmable by long pressing when used with a dimmable receiver.

Code	Description	Finish
ELA-37521	8mm X-Shape Connector 12-24V	White

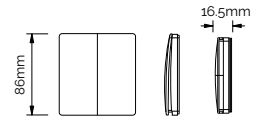

3 GANG SWITCH

IP67 on/off 1 gang switch. Dimmable by long pressing when used with a dimmable receiver.

Code	Description	Finish
ELA-37521	8mm X-Shape Connector 12-24V	White

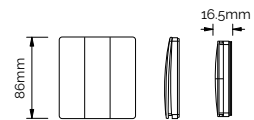

KEYFOB SWITCH

Switch on/off your lighting remotely from up to 160m away when outdoors and 30m away when indoors.

Code	Description	Finish
ELA-37521	8mm X-Shape Connector 12-24V	White

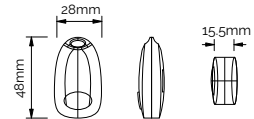

WIFI RECEIVER

The wireless receiver can be paired with any combination: a controller can be controlled by a maximum of 10 separate switches, a switch can pair an unlimited number of controllers.

Code	Description	Finish
ELA-37521	8mm X-Shape Connector 12-24V	White

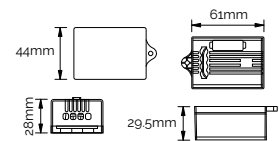

DIMMABLE WIFI RECEIVER

The wireless receiver can be paired with any combination: a controller can be controlled by a maximum of 10 separate switches, a switch can pair an unlimited number of controllers.

Code	Description	Finish
ELA-37521	8mm X-Shape Connector 12-24V	White

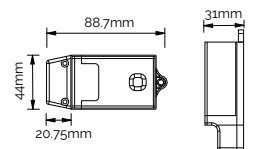

YATE

FIXED FIRE RATED DOWNLIGHT

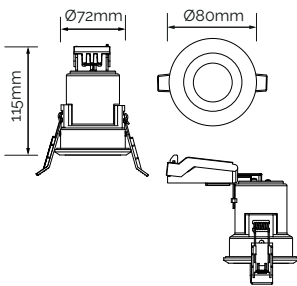

Yate fixed fire rated downlight features 30, 60 and 90 minutes fire rated protection. Suitable for homes with low ceilings and available in 6 different finishes.

YATE FIXED FIRE RATED DOWNLIGHT

Code	Finish	IP Rating	Lamp	Cutout	Size
ELA-27465-BCHR	Black Chrome	IP20	1 x 50W max GU10	Ø72mm	Ø80 x 115 x 135mm
ELA-27465-WHT	White	IP20	1 x 50W max GU10	Ø72mm	Ø80 x 115 x 135mm
ELA-27465-SCHR	Satin Chrome	IP20	1 x 50W max GU10	Ø72mm	Ø80 x 115 x 135mm
ELA-27465-CHR	Chrome	IP20	1 x 50W max GU10	Ø72mm	Ø80 x 115 x 135mm
ELA-27465-MBLK	Matt Black	IP20	1 x 50W max GU10	Ø72mm	Ø80 x 115 x 135mm
ELA-27465-SBRS	Satin Brass	IP20	1 x 50W max GU10	Ø72mm	Ø80 x 115 x 135mm

LAMP NOT INCLUDED



YATE

ADJUSTABLE FIRE RATED DOWNLIGHT

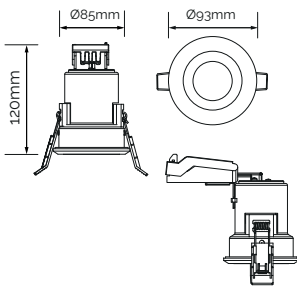

Yate adjustable fire rated downlight features 30, 60 and 90 minutes fire rated protection. Suitable for homes with low ceilings and available in 6 different finishes.

YATE ADJUSTABLE FIRE RATED DOWNLIGHT

Code	Finish	IP Rating	Lamp	Cutout	Size
ELA-27466-BCHR	Black Chrome	IP20	1 x 50W max GU10	Ø85mm	Ø93 x 120 x 135mm
ELA-27466-WHT	White	IP20	1 x 50W max GU10	Ø85mm	Ø93 x 120 x 135mm
ELA-27466-SCHR	Satin Chrome	IP20	1 x 50W max GU10	Ø85mm	Ø93 x 120 x 135mm
ELA-27466-CHR	Chrome	IP20	1 x 50W max GU10	Ø85mm	Ø93 x 120 x 135mm
ELA-27466-MBLK	Matt Black	IP20	1 x 50W max GU10	Ø85mm	Ø93 x 120 x 135mm
ELA-27466-SBRS	Satin Brass	IP20	1 x 50W max GU10	Ø85mm	Ø93 x 120 x 135mm

LAMP NOT INCLUDED



YATE

FIXED IP65 FIRE RATED DOWNLIGHT

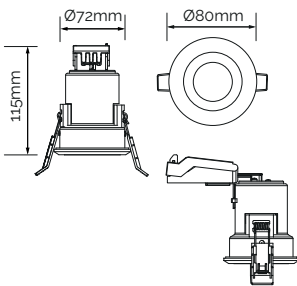

Yate fixed IP65 fire rated downlight features 30, 60 and 90 minutes fire rated protection. Suitable for homes with low ceilings and available in 6 different finishes. Can be used in bathrooms above showers.

YATE FIXED IP65 FIRE RATED DOWNLIGHT

Code	Finish	IP Rating	Lamp	Cutout	Size
ELA-27467-BCHR	Black Chrome	IP20	1 x 50W max GU10	Ø72mm	Ø80 x 115 x 135mm
ELA-27467-WHT	White	IP20	1 x 50W max GU10	Ø72mm	Ø80 x 115 x 135mm
ELA-27467-SCHR	Satin Chrome	IP20	1 x 50W max GU10	Ø72mm	Ø80 x 115 x 135mm
ELA-27467-CHR	Chrome	IP20	1 x 50W max GU10	Ø72mm	Ø80 x 115 x 135mm
ELA-27467-MBLK	Matt Black	IP20	1 x 50W max GU10	Ø72mm	Ø80 x 115 x 135mm
ELA-27467-SBRS	Satin Brass	IP20	1 x 50W max GU10	Ø72mm	Ø80 x 115 x 135mm

LAMP NOT INCLUDED



DECORATIVE CABLE SETS

Our decorative cable sets are a very on trend fitting which look great either over a breakfast bar or dining room table. We offer a range of colours and shade compatible options to fit your style.



CABLE SETS

Code	Finish	Size	Shade Compatible
INL-27988-ABRS	Antique Brass, Champagne Cable	Ø105 x 1000mm (adjustable)	Yes
INL-27988-ACOP	Antique Copper, Black Cable	Ø105 x 1000mm (adjustable)	Yes
INL-27988-PEW	Pewter, Black Cable	Ø105 x 1000mm (adjustable)	Yes
INL-27988-BRZ	Bronze, Black Cable	Ø105 x 1000mm (adjustable)	Yes
INL-27988-SNIC	Satin Nickel, Grey Cable	Ø105 x 1000mm (adjustable)	Yes

LAMP NOT INCLUDED

range of LED vintage lamps available - see pages 40-41
range of shades available - see pages 38-39

E27



CABLE SETS

Code	Finish	Size	Shade Compatible
INL-23519-BLK	Black Nickel, Black Twisted Cable	Ø118 x 1100mm (adjustable)	No
INL-23519-GRY	Black Nickel, Grey Twisted Cable	Ø118 x 1100mm (adjustable)	No
INL-23519-RED	Polished Nickel, Red Twisted Cable	Ø118 x 1100mm (adjustable)	No
INL-23519-HERR	Polished Nickel, Herringbone Cable	Ø118 x 1100mm (adjustable)	No

LAMP NOT INCLUDED

range of LED vintage lamps available - see pages 40-41

E27



7 LIGHT CABLE SET

Code	Finish	Size	Shade Compatible
INL-31789-ACOP	Antique Copper, Black Twisted Cable	Ø600 x 2000mm (adjustable)	No

LAMPS NOT INCLUDED

range of LED vintage lamps available - see pages 40-41

E27

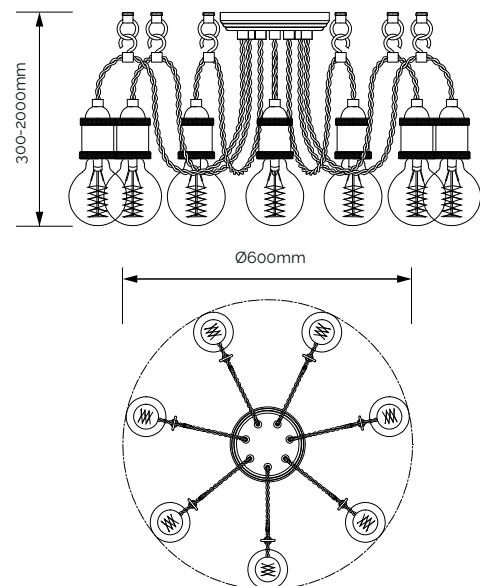

DINER SHADES

This industrial diner style pendant light looks great in a dining room, kitchen, or living room, with a shallow shade directing the light to a wider area for a more effective spread of light in the room. Our pendant lighting kits are a perfect match with an industrial style filament bulb page 40-41.

- Compatible with INL-27988 cable kits
- A range of colour combinations to suit your kitchen/dining room

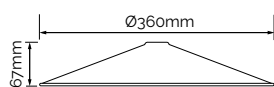
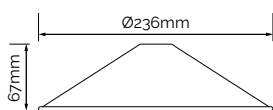

RIGEL DINER SHADE

Code	Finish	Size
INL-33818-ABRS	Antique Brass	Ø236 x 67mm
INL-33818-MBLK	Matt Black	Ø236 x 67mm
INL-33818-PNIC	Polished Nickel	Ø236 x 67mm
INL-33818-ACOP	Antique Copper	Ø236 x 67mm
INL-33818-MGRY	Matt Grey	Ø236 x 67mm
INL-33819-ABRS	Antique Brass	Ø360 x 67mm
INL-33819-MBLK	Matt Black	Ø360 x 67mm
INL-33819-PNIC	Polished Nickel	Ø360 x 67mm
INL-33819-ACOP	Antique Copper	Ø360 x 67mm
INL-33818-MGRY	Matt Grey	Ø360 x 67mm



AGOL COOLIE EASYFIT SHADE

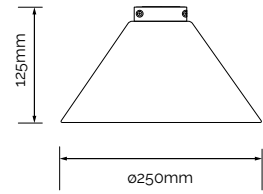

Code	Finish	Size	Fits
INL-33136-SMK	Smoke	Ø250 x 125mm	E27/B22 lampholders



AGOL SPHERE EASYFIT SHADE

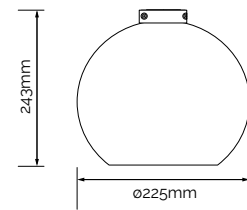

Code	Finish	Size	Fits
INL-33137-CHAMP	Champagne	Ø243 x 225mm	E27/B22 lampholders



CASTOR ONION EASYFIT SHADE

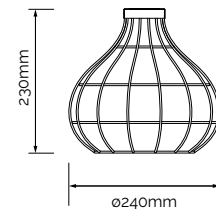

Code	Finish	Size	Fits
INL-33139-MBLK	Matt Black	Ø240 x 230mm	E27/B22 lampholders



CASTOR DIAMOND EASYFIT SHADE

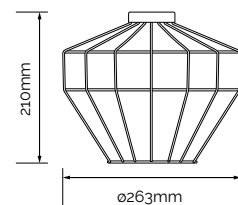

Code	Finish	Size	Fits
INL-33140-ACOP	Antique Copper	Ø263 x 210mm	E27/B22 lampholders



G180 LARGE VINTAGE LED LAMP

E27 2000K

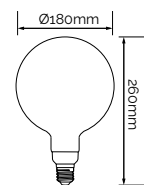

Code	Colour (k)	Lumens	Finish	Size
INL-34028-AMB	2000	450	Amber	Ø180 x 230mm
INL-34028-SMK	2000	450	Smoke	Ø180 x 230mm



A165 LARGE VINTAGE LED LAMP

E27 2000K

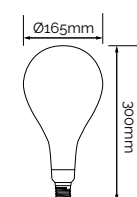

Code	Colour (k)	Lumens	Finish	Size
INL-34029-AMB	2000	450	Amber	Ø165 x 300mm
INL-34029-SMK	2000	450	Smoke	Ø165 x 300mm



BT180 LARGE VINTAGE LED LAMP

E27 2000K

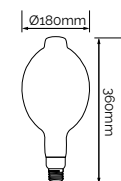

Code	Colour (k)	Lumens	Finish	Size
INL-34030-AMB	2000	450	Amber	Ø180 x 360mm
INL-34030-SMK	2000	450	Smoke	Ø180 x 360mm



T80 LARGE VINTAGE LED LAMP

E27 2000K



Code	Colour (k)	Lumens	Finish	Size
INL-34031-AMB	2000	450	Amber	Ø80 x 330mm
INL-34031-SMK	2000	450	Smoke	Ø80 x 330mm



ST64 VINTAGE LED LAMP

E27 2000K

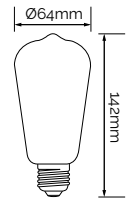

Code	Colour (k)	Lumens	Finish	Size
INL-ST64-LED-ES-TNT	2000	580	Amber	Ø64 x 140mm
INL-ST64-LED-ES-CLR	2000	650	Clear	Ø64 x 140mm



G80 VINTAGE LED LAMP

E27 2000K

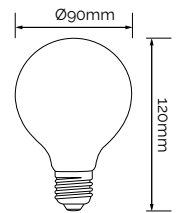

Code	Colour (k)	Lumens	Finish	Size
INL-G80-LED-ES-TNT	2000	400	Amber	Ø80 x 120mm
INL-G80-LED-ES-CLR	2000	450	Clear	Ø80 x 120mm



G95 VINTAGE LED LAMP

E27 2000K

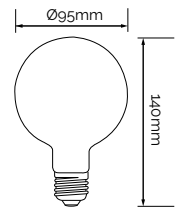

Code	Colour (k)	Lumens	Finish	Size
INL-G95-LED-ES-TNT	2000	580	Amber	Ø95 x 140mm
INL-G95-LED-ES-CLR	2000	650	Clear	Ø95 x 140mm

Any typographical, clerical or other error or omission in any sales literature, quotation, price list, acceptance of offer, invoice or other document or information issued by the Company shall be subject to correction without any liability on the part of the Company. Goods supplied may vary in detail from the illustrations, drawings, measurements and descriptions set out in the Company's sales literature, which are approximate and for guidance only and will not form part of the Contract. Colour finishes will be maintained as accurately as possible but matching cannot be guaranteed. All terminology used in the Company's sales literature is, subject to these Conditions, that as understood by general usage in the trade. For full terms and conditions of sale consult your distributor.

CULINA

FEB21.v1

CULINA

CULINA KITCHEN LIGHTING

Corse Mill, Gorse Street,
Oldham, OL9 9RJ, UK

t +44 (0) 161 359 4949

f +44 (0) 161 628 2831

e info@forumlightingsolutions.com

w forumlightingsolutions.com